

KDL/D-mono cable entry system

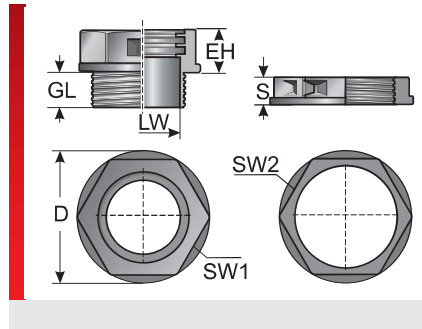









KDL/C -/D -/H cable entry system

PRODUCT INFORMATION

The KDL/D-mono is a split cable entry system for inserting pre-assembled cables. Depending on the choice of cable entry grommet, up to four cables can be introduced. The split lock nut is included within the scope of delivery.

- Easy assembly and installation of pre-assembled cables
- Integrated and split seal
- Simple strain relief for cables using cable ties
- Matching grommet: KDT/X

SPECIFICATIONS

	Polyamide 6
	-30 – 100 °C
	IP 65
	V0
	
	
	
	

Type	Order No.	Colour	No. Openings			Thread	Pack qty.
			Small	medium	large		
KDL/D-mono 1 M25	87141610	Black	1	0	0	M25x1.5	5
KDL/D-mono 1 M32	87141620	Black	0	1	0	M32x1.5	5
KDL/D-mono 1 M40	87141636	Black	0	1	0	M40x1.5	5
KDL/D-mono 2 M40	87141630	Black	2	0	0	M40x1.5	5
KDL/D-mono 1 M50	87141640	Black	0	0	1	M50x1.5	5

DIMENSION TABLE

Type	Order No.	Installation height (EH) mm	Thread length (GL) mm	Diameter (D) mm	Width across flats (SW1/SW2) mm
KDL/D-mono 1 M25	87141610	18.50	15.00	40.00	36.00 / 28.00
KDL/D-mono 1 M32	87141620	18.00	15.00	50.00	46.00 / 36.00
KDL/D-mono 1 M40	87141636	18.00	20.00	62.00	55.00 / 46.00
KDL/D-mono 2 M40	87141630	18.00	20.00	62.00	55.00 / 46.00
KDL/D-mono 1 M50	87141640	22.00	20.00	62.00	55.00 / 55.00

 Polyamide 6

 **Temperature / temperature range**
-30 – 100 °C

KDL/D-mono cable entry system

 **Protection class**
IP 65

 **Fire classification**
V0

 **LABS free**

 **UV-resistant**

 **RoHS (EC Directive 2011/65/EC)**

 **Made in Germany**

KDL/C -/D -/H cable entry system

M. Buttkereit Ltd
Unit 2, Britannia Rd Ind Est
Sale, Cheshire, M33 2AA

Tel. 0161 969 5418
info@buttkereit.co.uk

www.buttkereit.co.uk